

SHTM SAFETY HARBOR FIREARMSTM INC.



**SHF R50TM
SHF S50TM**

**Safety Harbor Firearms, Inc.
PO Box 563
Safety Harbor, FL 34695-0563
Ph: 727-726-2500
Fax: 727-797-6134**

www.safetyharborfirearms.com

⚠ WARNING

Risk of serious injury or death.

Failure to read this manual and to follow the instructions may result in serious injury or death to you or to others.

Be sure you understand all instructions and hazards associated with firearms before using this firearm.

Safety	3
Safety Alert Symbol And Signal Words	3
Safety Is Critical To Performance	4
Safety Guidelines	4
Identification	7
Model And Serial Number	7
Part Identification	7
Inspect For Ammunition	8
Ammunition	11
Loading	13
Magazine Fed Ammunition	13
Single Shot	16
Firing	17
Malfunctions	20
Unloading	23
Disassemble For Cleaning	26
Disassembly	26
Clean And Inspect Parts	29
Assembly	29
Cleaning	32
Cleaning The Barrel	32
Cleaning The Chamber	33
Cleaning The Exterior	33
Definition of Terms	34
Parts Listings	35
Rifle Major Components	35
Upper Receiver	36
Trigger Group	37
Stock	38
Service	39
Customer Service	39
Returns	39
Exchanges	39

SAFETY

 You must read and understand this manual before using this firearm.

You must follow all safety precautions and instructions.

If you do not understand any part of this manual or you are unsure about the operation of your firearm, contact Safety Harbor Firearms before proceeding.

SAFETY ALERT SYMBOL AND SIGNAL WORDS

This manual provides instructions on the operation and maintenance of rifles made by Safety Harbor Firearms. You must read, understand and follow the instructions and safety warnings in this manual. The safety of yourself and those around you, depends on the knowledge you have of your rifle, and your knowledge of the safety guidelines common to all firearms.

The safety information in this manual is denoted by the safety alert symbol: 

The level of risk is indicated by the following signal words.

DANGER

Indicates a hazardous situation, which, if not avoided, will result in death or serious injury.

WARNING

Indicates a hazardous situation, which, if not avoided, could result in death or serious injury.

CAUTION

Indicates a hazardous situation, which, if not avoided, could result in minor or moderate injury.

NOTICE

Indicates a situation that could result in damage to the equipment or other property.







SAFETY IS CRITICAL TO PERFORMANCE









A firearm is only as good as the hands that hold it. Shooting accidents are often caused by careless oversights. These oversights can result in the loss of life, limb or property. Proper use and performance of your firearm depends on correct assembly and maintenance, which is why it is critical you read and understand the information in this manual. Use the following safety guidelines in every situation.

SAFETY GUIDELINES







WARNING

You must follow all of the safety guidelines to ensure the safe use of your firearm. Failure to follow these basic firearm safety guidelines may result in an unintended discharge which could cause serious injury or death.

-  You are responsible for your firearm at all times. You must protect yourself and others against injury or death from misuse of a firearm.
-  Treat every firearm as if it's loaded.
-  A dropped firearm may discharge. Do not drop your firearm.
-  Always keep your firearm pointed in a safe direction. Never point a firearm at anyone whether the firearm is loaded or not. Be careful when you're loading or unloading your firearm.
-  Firearms must be unloaded when not in use. Load your firearm only when you are in the field or target range and ready to fire. Never let a loaded firearm out of your sight. Completely unload your firearm as soon as you are finished shooting, before storing, traveling, standing it against anything, laying it down, entering a vehicle, building or bring it into your home. Do not take anyone's word that a firearm is unloaded, always verify for yourself. Never pass your firearm to another person until you visually check that it is unloaded. Keep your firearm unloaded and safely stored when not in use.
-  Never rely on your firearm mechanical features alone. Only your safe handling of your firearm, will ensure the safe use of your firearm. A mechanical safety is not a substitute for common sense. It is merely a supplement to your safe handling of a firearm. Never touch the trigger or trigger guard until you are ready to fire. Be sure that no other objects touch the trigger. Never climb a tree or cross obstacles such as streams, creeks or fences with a loaded firearm.

-  Verify the barrel is clear of obstructions before loading and firing. Completely unload the firearm and check the barrel for any obstructions or debris. Never let water, snow, mud or other materials enter the barrel. Excess lubricants or grease can dangerously increase pressure and may cause barrel to burst when firing. If barrel is obstructed, remove ammunition and clean barrel immediately.
-  Every firearm is designed to use a certain gauge or caliber of ammunition. Never use incorrect ammunition, non-standard, or “handloaded” ammunition which has not been subjected to internal ballistic pressure testing. Always read and follow the instructions on the ammunition box.
-  Be sure of your target and the surrounding area. Never fire unless you know exactly where your shot is going and what it will strike. Make sure the shot has a safe back stop, such as a hillside or sand. Bullets can ricochet on surfaces such as water. Do not fire into the sky.
-  Safely store and secure your firearm and ammunition separately. Store your firearm and ammunition so that they are not accessible to children or unauthorized persons. Evaluate your situation to be sure children and unauthorized persons can not access your firearm.
-  Never lock a loaded firearm and never load a locked firearm.
-  Always wear appropriate eye and ear protection while shooting and cleaning a firearm. Be sure others in the vicinity have protection.
-  Never use drugs or alcohol before or during use of firearm. Never use your firearm if you are taking any medication which impairs, even slightly, your mental or physical ability.
-  Obey all laws regarding the storage, security, transportation and carrying of firearms. You must be familiar with all local, state, and federal laws regarding the safe use, storage and/or transportation of your firearm. Your local police department can answer any questions you may have regarding the legal use, storing and/or transporting of your firearm.
-  Discharging firearms in poorly ventilated areas, cleaning the firearm and the handling of ammunition may result in exposure to lead and other substances known to cause birth defects, reproductive harm, cancer, and other physical injury. Wash hands thoroughly after

exposure. Read the warnings and labels of all ammunition and cleaning products carefully.

-  Understand all operational aspects of the firearm before handling. Every firearm is different. Familiarize yourself with all mechanical features of your firearm. If you do not understand any part of this manual or you are unsure about the operation of your firearm, contact Safety Harbor Firearms at 1-727-726-2500 before proceeding.
-  If your firearm fails to fire when the trigger is pulled, handle with care. Keep the firearm pointed in a safe direction. Keeping your face away from the breach, put the safety on. Unload your firearm and dispose of the ammunition safely.
-  Never alter or modify your firearm. Never disassemble your firearm beyond what is outlined in this manual. Improper manipulation of any internal components and/or improper disassembly or reassembly may be dangerous, and may lead to serious injury or death. Do not try to change your firearm's trigger pull, alterations might cause accidental firing. Only a qualified gunsmith should service, repair or modify your firearm in any way.
-  Be sure all accessories are compatible with your firearm. Accessories must not interfere with the safe operation of your firearm.
-  Never allow your firearm to be used by an individual who does not understand its safe operation or has not read these firearm safety guidelines.
-  The safe use of your firearm is your responsibility. Failure to follow all of these basic safety guidelines may result in severe injury or death to you or others.

You, the owner, are the most important safety device when it comes to the use of your Safety Harbor Firearm. Under no circumstances will Safety Harbor Firearms, Inc. be responsible for any injury, death or property damage that results from:

- A disregard of the safety guidelines and warnings;
- The criminal or negligent use of the firearm;
- Improper or careless handling of the firearm;
- Improper or negligent modifications or repairs to the firearm;
- The use of non-standard, defective, improper or reloaded ammunition.

-  This manual must accompany this firearm and be transferred with it upon change of ownership or when presented to another person.

IDENTIFICATION

MODEL AND SERIAL NUMBER

The serial number (A) and model number (B) are located on the left side of the firearm. See figure 1.



Figure 1

PART IDENTIFICATION

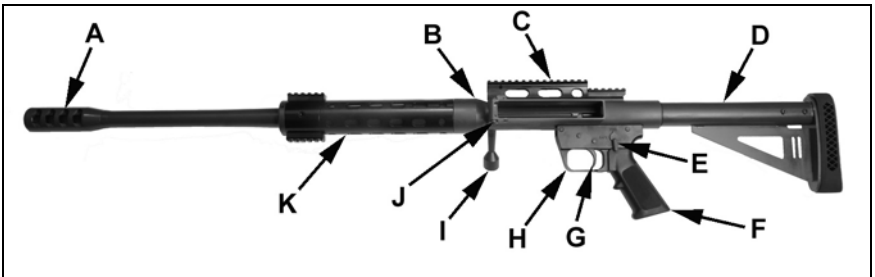

Figure 2

- A - Muzzle Brake
- B - Upper Receiver
- C - Scope Mount
- D - Stock
- E - Safety Lever

- F - Grip
- G - Trigger
- H - Trigger Guard
- I - Bolt Assembly

- J - Magazine Well
(N/A On Single
Shot Rifles)
- K - Handguard

INSPECT FOR AMMUNITION

⚠ WARNING

Risk of serious injury or death.

A loaded firearm may discharge unintentionally.

Point the firearm in a safe direction while inspecting for ammunition.

1. **Remove Magazine (If Equipped).** Grasp the firearm while keeping your finger off the trigger. Place your left hand on the forward end of the magazine (A) as illustrated. Press the magazine release button (B) forward to OPEN and pull the forward end of the magazine out to remove. See figure 3.

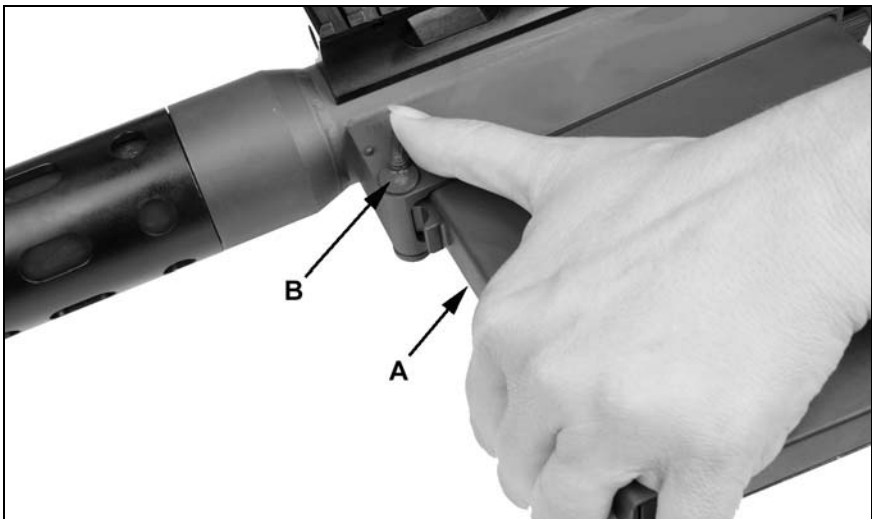

Figure 3

2. Lift up on bolt (C) and pull back into slot (D) in one smooth motion. See figure 4.



Figure 4

! 3. Place the safety selector lever (E) on SAFE. See figure 5.



Figure 5

4. Look into the receiver through the ejection port and verify that there is no cartridge in the chamber (F). See figure 6.

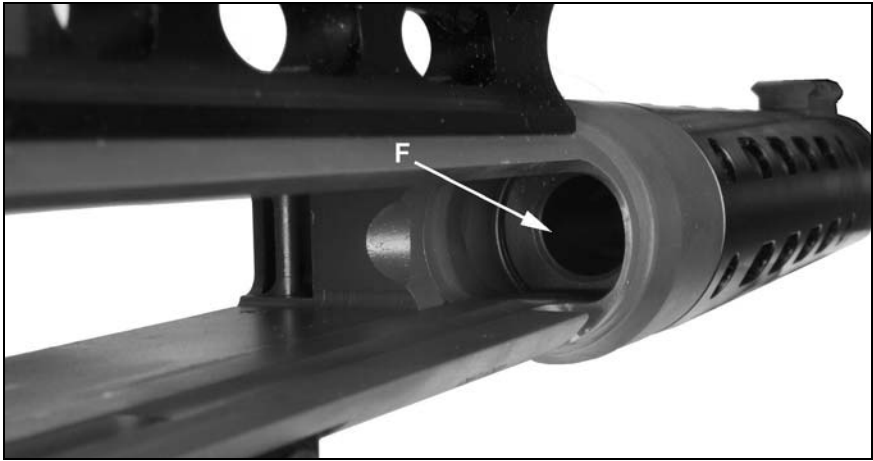

Figure 6

5. Follow this inspection procedure before storage, before cleaning, before transporting, before handing to another person or when handed to you.

AMMUNITION

⚠ DANGER

Risk of serious injury or death.

Failure to use the proper gauge or caliber of ammunition will cause your firearm to fail when firing.

Always use ammunition specifically designed for use in your firearm.

- ⚠** You are responsible for using ammunition specifically designed for and that meets industry standards for use in your firearm.
- ⚠** Using ammunition not specifically designed for your firearm can cause the pressure to exceed the capability of your firearm, and could damage and/or rupture your firearm.
- ⚠** Never mix ammunition.

Locate the caliber mark (A) on the left side of the firearm. See figure 7. This designates the ammunition caliber that must be used in your firearm.



Figure 7

Your firearm has been designed for ammunition of a specific caliber and type. The firearm and ammunition work together as a system. You must use the correct ammunition for your firearm.

Always inspect your ammunition before using it. Never use damaged or corroded ammunition which could lead to a burst cartridge causing damage to the firearm and possible injury or death.

Always use ammunition that is commercially manufactured with internal ballistic pressures which are in strict accordance with the specifications of the Sporting Arms and Ammunitions Manufacturers' Institute (SAAMI). For verification, contact your ammunition supplier.

 **WARNING**

Risk of serious injury or death.

Use of “handloaded”, reloaded or non-standard ammunition may result in your firearm failing to fire, jam, or to dangerously increase pressure and cause barrel to burst when firing.

Use only quality commercially manufactured ammunition.

LOADING



WARNING

Risk of serious injury or death.

A loaded firearm may discharge unintentionally if dropped.

Handle the loaded firearm with care.

Clean your firearm before the first use. Your firearm has been treated at the factory to prevent corrosion. The chamber, bore and exterior surfaces must be cleaned to remove excess oil.

-  You must read and understand this manual before loading.
-  Load your firearm only when you are in the field or target range, when you are sure of the target and ready to fire.

MAGAZINE FED AMMUNITION

1. Inspect the firearm for ammunition if you have not done so. See Inspect For Ammunition in this manual.

WARNING

Risk of serious injury or death.

Using damaged, incorrect, non-standard or “hand loaded” ammunition may result in firearm failure or misfire.

Use only quality undamaged ammunition in your firearm.

2. Inspect each cartridge for signs of damage. Do not load damaged ammunition. Load the magazine with the proper caliber of undamaged ammunition.

3. Insert tab on the rear of the magazine (A) into tab slot on the magazine well. See figure 8.

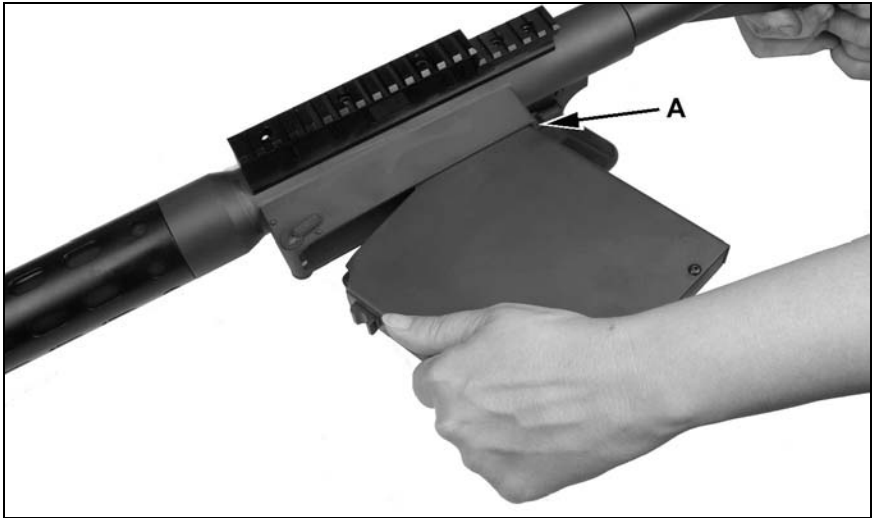

Figure 8

4. Tap on end of the magazine with your hand until magazine latch (B) is engaged. See figure 9.



Figure 9

5. Verify the safety lever is in the SAFE position.

⚠ WARNING

Risk of serious injury or death.

After performing step 6, the firearm is loaded and will fire if the safety selector is set to FIRE and the trigger is pulled.

Keep the firearm pointed in a safe direction at all times.

6. To load a round into the chamber, push the bolt handle (C) fully forward and down. A round from the magazine is now loaded into the chamber. See figures 10 and 11.

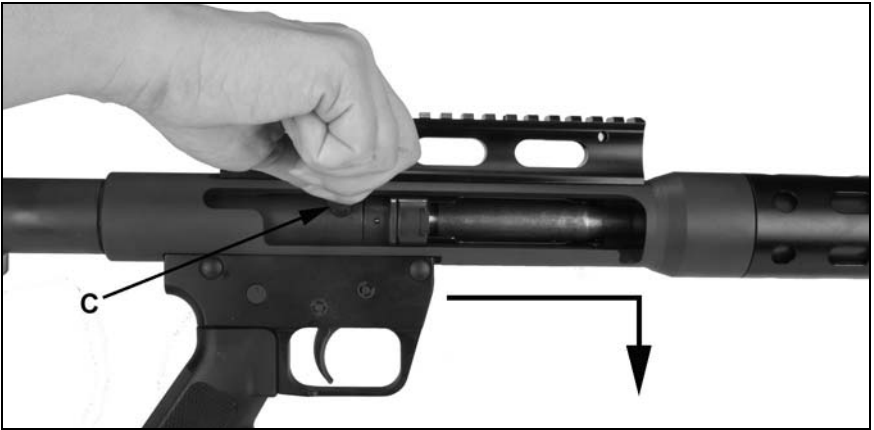

Figure 10

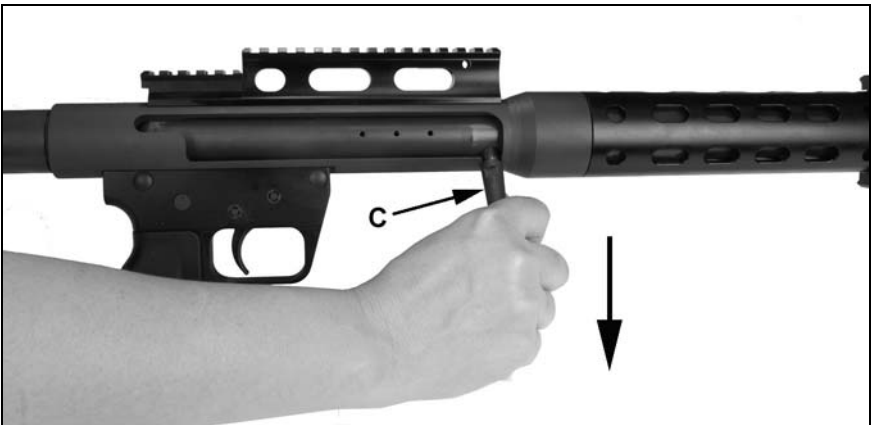

Figure 11

SINGLE SHOT

1. Inspect the firearm for ammunition if you have not done so. See Inspect For Ammunition in this manual.

⚠ WARNING

Risk of serious injury or death.

Using damaged, incorrect, non-standard or “hand loaded” ammunition may result in firearm failure or misfire.

Use only quality undamaged ammunition in your firearm.

2. Inspect each cartridge for signs of damage. Do not load damaged ammunition. Insert one round of ammunition into the chamber.

- ⚠** 3. Verify the safety lever is in the SAFE position.

⚠ WARNING

Risk of serious injury or death.

After performing step 4, the firearm is loaded and will fire if the safety selector is set to FIRE and the trigger is pulled.

Keep the firearm pointed in a safe direction at all times.

4. Push the bolt handle (A) fully forward and down. A round is now loaded into the chamber. See figure 12.

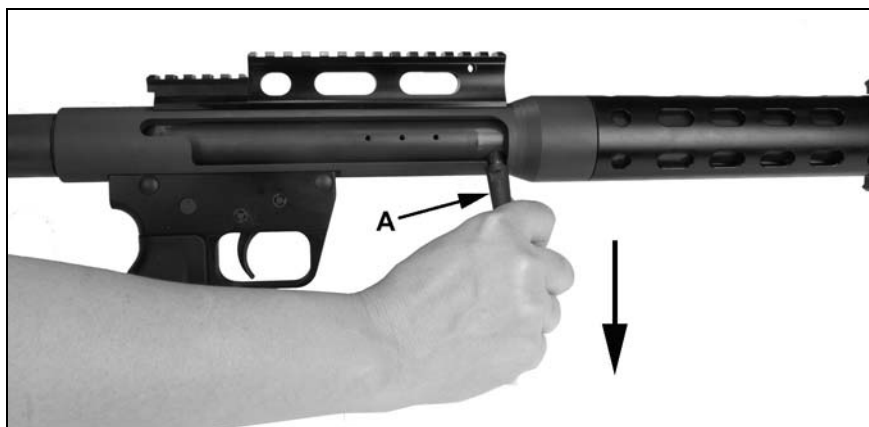

Figure 12

FIRING

⚠ WARNING

You must follow all of the safety guidelines to ensure the safe use of your firearm. Failure to follow these basic firearm safety guidelines may result in an unintended discharge which could cause serious injury or death.

- ⚠** Always point the barrel in a safe direction.
 - ⚠** Be alert and follow safety instructions.
 - ⚠** Be aware of others. Persons in the vicinity may unintentionally walk into your line of fire.
 - ⚠** The proper eye and ear protection must be worn by the shooter and bystanders in the area.
1. Grasp the firearm with one hand on the hand guard and the other on the grip. Keep fingers away from the trigger and trigger guard.
 2. Place the buttstock firmly against your shoulder.
 3. Mover the safety lever (A) to FIRE. See figure 13.



Figure 13

4. Aim at the target and gently pull the trigger with your index finger to fire. Release the trigger.
5. Lift up on bolt (B) and pull back into slot (C) in one smooth motion to eject spent round. See figure 14.

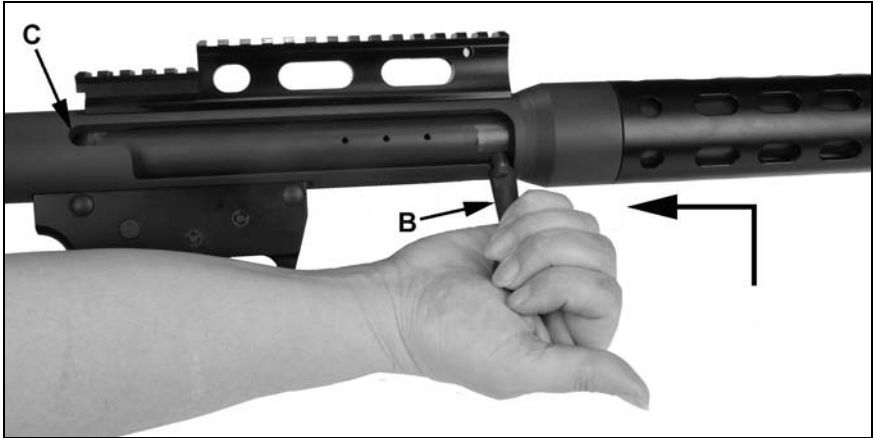

Figure 14

6. To load a round into the chamber, push the bolt handle (B) fully forward and down. A round from the magazine is now loaded into the chamber. See figures 15 and 16.

For single shot rifles, load a round into the chamber and push the bolt handle (B) fully forward and down. See figures 15 and 16.

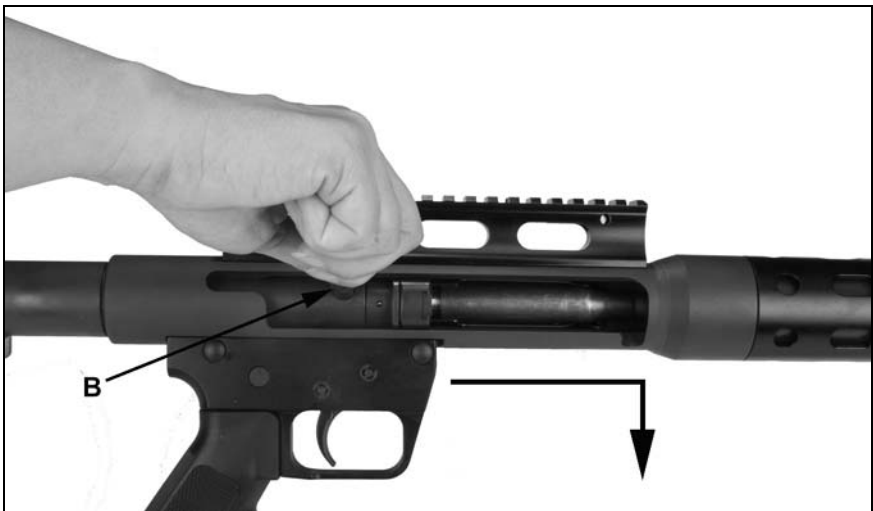

Figure 15

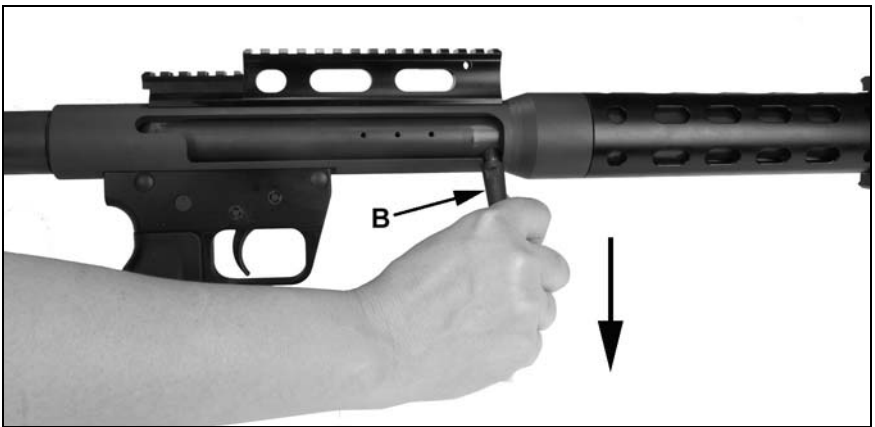

Figure 16

7. When you stop firing, remove your finger from the trigger and place the safety lever (A) in the SAFE position. See figure 17.



Figure 17

8. Remove and reload magazine or reload chamber if you plan to continue shooting.

⚠ WARNING

Risk of serious injury or death.

The firearm may have a round in the chamber even though the magazine has been removed.

Keep the firearm pointed in a safe direction while the magazine is reloaded.

9. Unload the firearm using the Inspect For Ammunition procedure in the manual.

MALFUNCTIONS

⚠ WARNING

Risk of serious injury or death.

If your firearm is not operating properly, stop firing immediately.

Point the firearm in a safe direction and unload the firearm.

Safely store the firearm and take it a qualified gunsmith for inspection.

⚠ If a cartridge jams or hangs up while moving from the magazine into the chamber, do not attempt to force the cartridge into the chamber.

If your firearm misfires or jams:

- ⚠** 1. Remove your finger from the trigger area, point the firearm in a safe direction and wait 10-15 seconds.
- 2. Remove Magazine (If Equipped)** Grasp the firearm while keeping your finger off the trigger. Place your left hand on the forward end of the magazine (A) as illustrated. Press the magazine release button (B) forward to OPEN and pull the magazine out to remove. See figure 18.

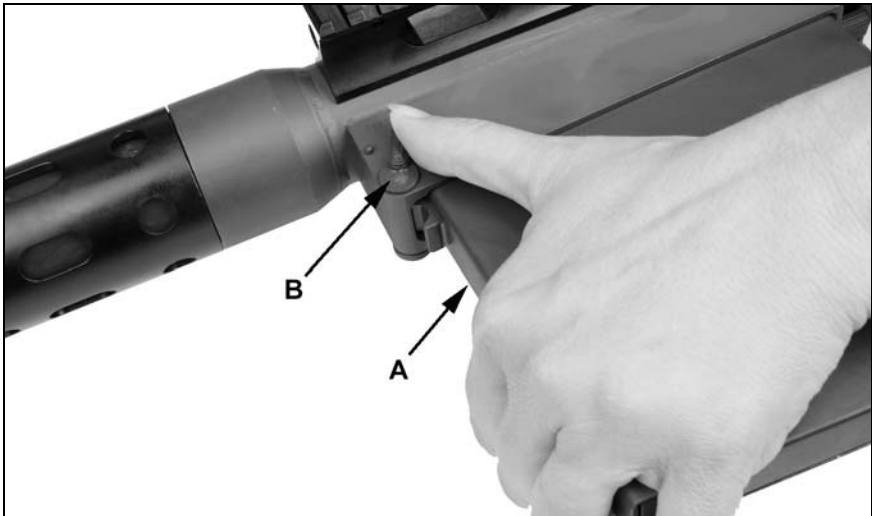

Figure 18

3. Lift up on bolt (C) and pull back into slot (D) in one smooth motion. See figure 19.

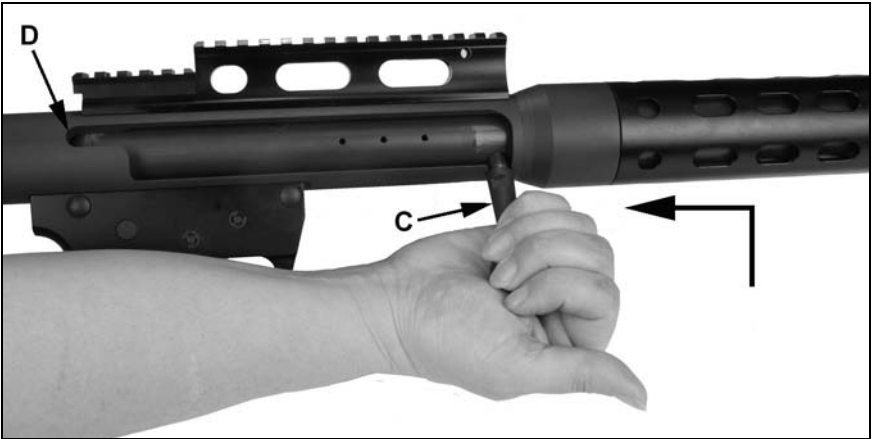

Figure 19

4. Place the safety selector lever (E) on SAFE. See figure 20.



Figure 20

5. Look into the receiver through the ejection port and verify that there is no cartridge in the chamber (F). See figure 21.

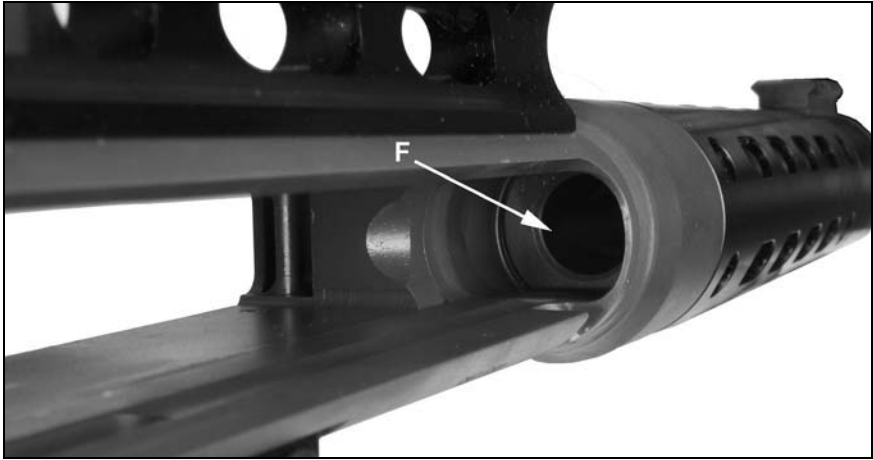

Figure 21

6. If a cartridge can not be removed, safely store the firearm and take it a qualified gunsmith for inspection and/or repairs.

UNLOADING

⚠ WARNING

Risk of serious injury or death.

A loaded firearm may discharge unintentionally.

Point the firearm in a safe direction while inspecting for ammunition.

- 1. Remove Magazine (If Equipped)** Grasp the firearm while keeping your finger off the trigger. Place your left hand on the forward end of the magazine (A) as illustrated. Press the magazine release button (B) forward to OPEN and pull the forward end of the magazine out to remove. See figure 22.

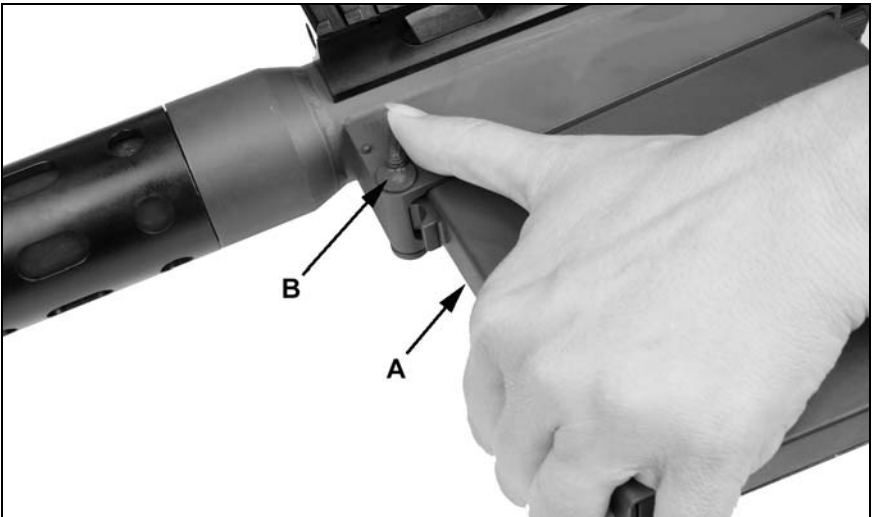

Figure 22

2. Lift up on bolt (C) and pull back into slot (D) in one smooth motion. See figure 23.

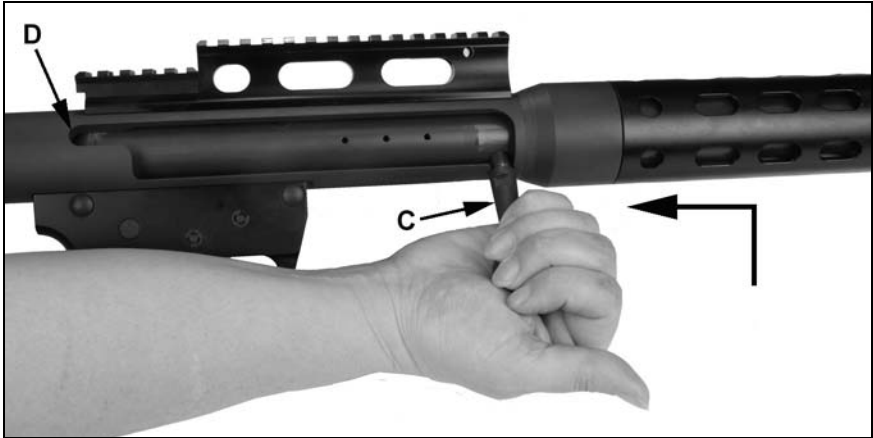

Figure 23

3. Place the safety selector lever (E) on SAFE. See figure 24.



Figure 24

4. Look into the receiver through the ejection port and verify that there is no cartridge in the chamber (F). See figure 25.

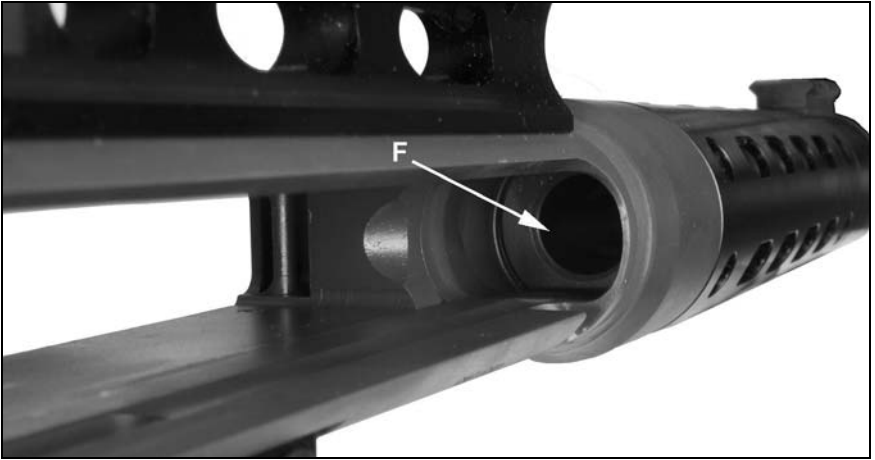

Figure 25

5. Follow this inspection procedure before storage, before cleaning, before transporting, before handing to another person or when handed to you.

DISASSEMBLE FOR CLEANING

WARNING

Risk of serious injury or death.

Always point the firearm in a safe direction.

Verify that the firearm is not loaded before any disassembly or cleaning.

WARNING

Risk of serious injury or death.

Do not disassemble the firearm any further than instructed in this manual.

Do not modify or alter any part of the firearm.

Wear the appropriate protective clothing while disassembling and assembling the firearm.

DISASSEMBLY

 Disassembling the firearm and the handling of ammunition and cleaning products may result in exposure to lead and other substances known to cause birth defects, reproductive harm, cancer, and other physical injury. Wash hands thoroughly after exposure. Read and follow the warnings and labels of all ammunition and cleaning products carefully.

 1. Verify that the firearm is not loaded. See Unloading in this manual.

2. Remove pins (A) and remove stock (B). See figure 26.

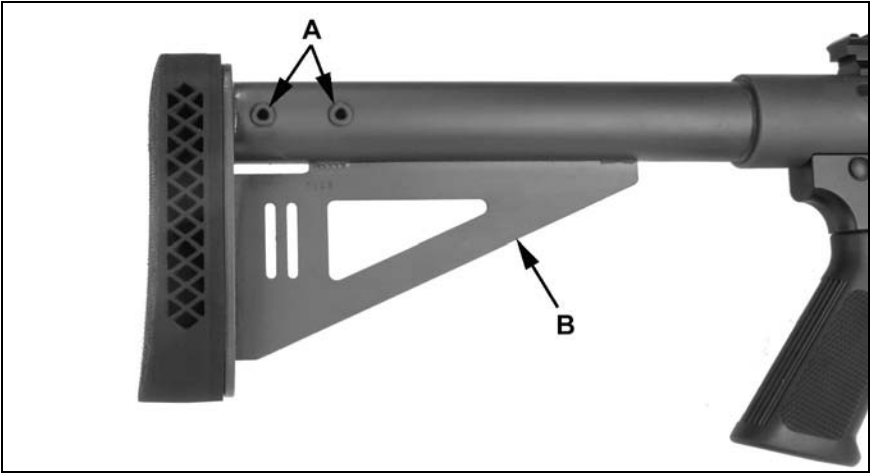

Figure 26

3. Using a $\frac{3}{8}$ wrench, turn bolt handle (C) counter clockwise to remove. See figure 27.

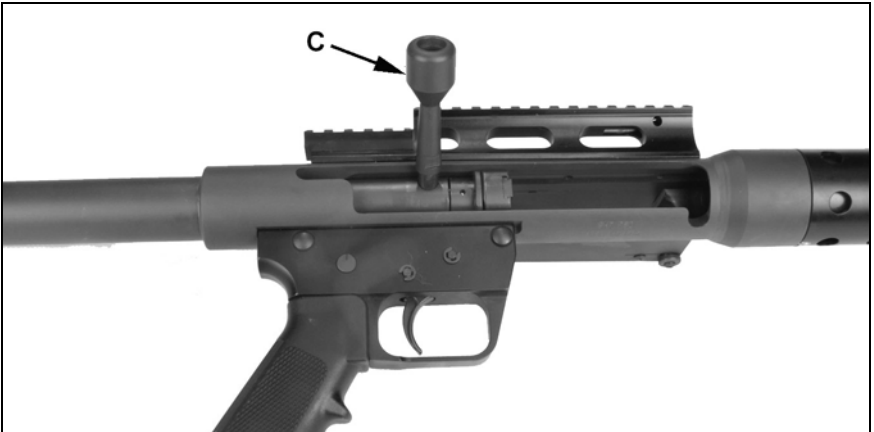

Figure 27

5. Remove bolt head (D) and firing pin (E) through magazine well or ejection port. See figure 28.

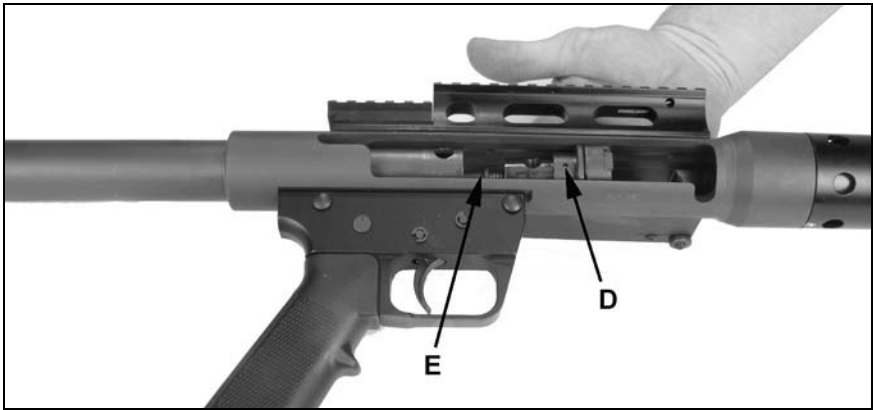

Figure 28

6. Remove bolt body (F) from the rear of the receiver. See figure 29.

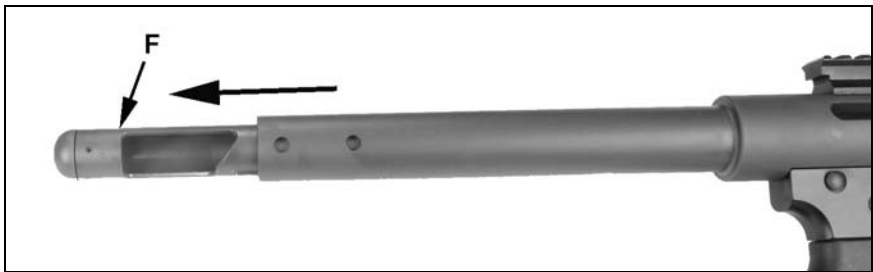

Figure 29

7. Remove two pins (G) to separate upper from trigger group. See figure 30.

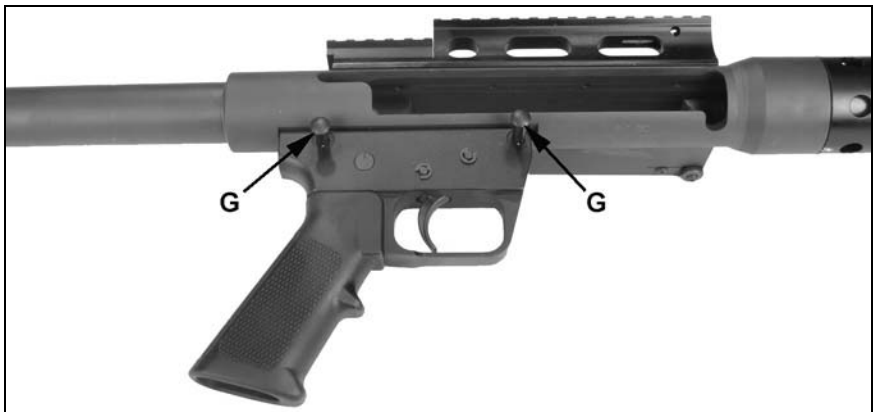

Figure 30

⚠ WARNING

Risk of serious injury or death.

Do not disassemble the firearm any further than instructed in this manual.

Do not modify or alter any part of the firearm.

Replacement parts must be installed by a qualified gunsmith.

CLEAN AND INSPECT PARTS

Clean components with a quality gun cleaning solution. Lubricate components with a quality gun lubricant.

Inspect all parts for wear and damage. Carefully inspect the firing pin. Replace pin if worn, bent or if the tip is deformed.

ASSEMBLY

1. Install upper to trigger group and insert pins (G). See figure 31.

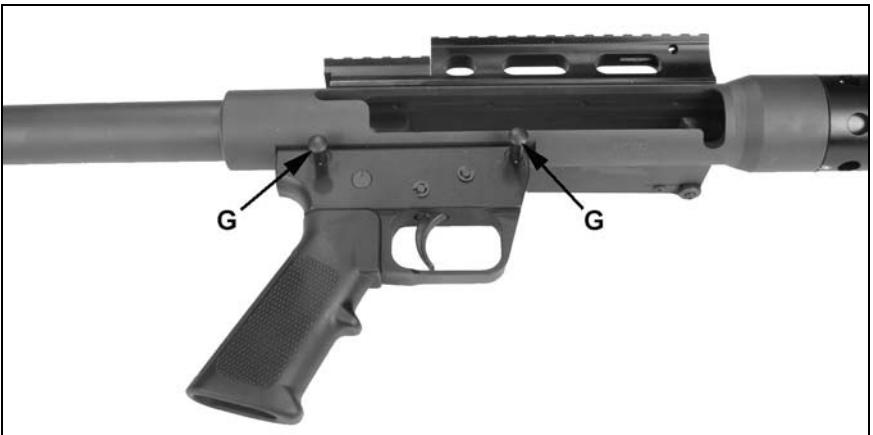

Figure 31

2. Insert bolt body (F) into lower receiver. See figure 32.

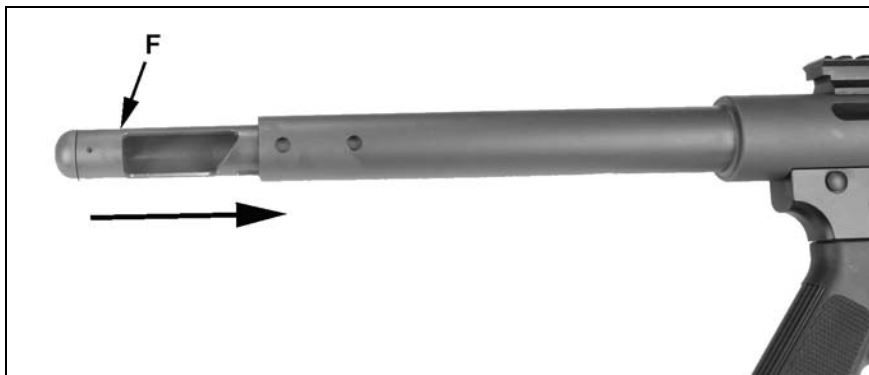

Figure 32

3. Install firing pin (E) and bolt (D) into upper receiver. See figure 33.

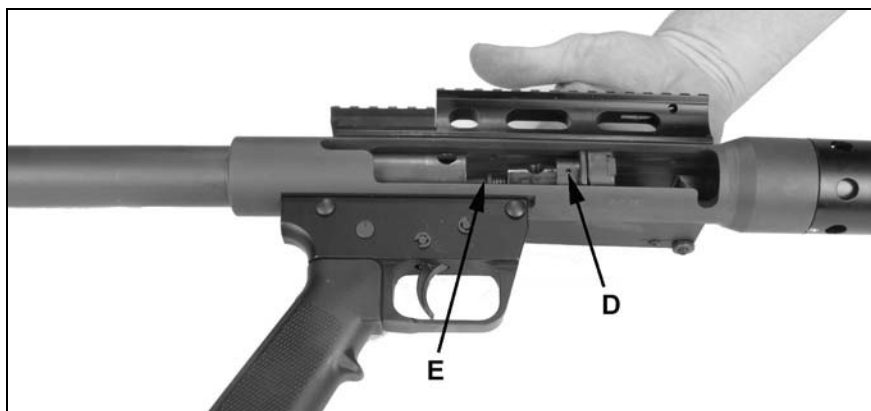

Figure 33

4. Install bolt handle (C) and tighten to 5-10 lb/ft of torque. See figure 34.

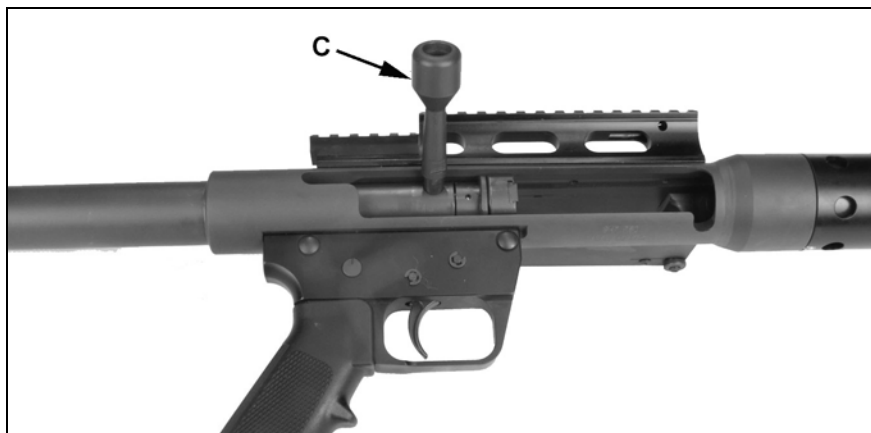

Figure 34

5. Install stock (B) and pins (A). See figure 35.

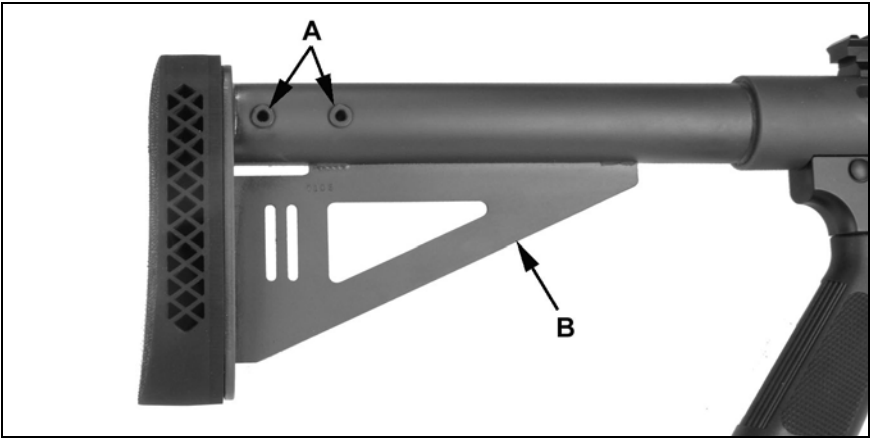

Figure 35

CLEANING

WARNING

Risk of serious injury or death.

Always point the firearm in a safe direction.

WARNING

Risk of serious injury or death.

Verify that the firearm is not loaded before any disassembly or cleaning.

NOTICE

Risk of firearm damage.

Some cleaning solutions and solvents may damage your firearm.

Use a cleaning solution that is designed for use on firearms.

NOTICE

Risk of firearm damage.

Do not allow cleaning rods to scratch the inside of the barrel or chamber.

Commercial firearm cleaning kits are available from your firearms distributor. Follow the instructions included with the cleaning kit.

Clean the firearm before the first use to remove excess oil.

CLEANING THE BARREL

-  Remove the magazine (if equipped) and verify that the firearm is not loaded and safety is on SAFE.

Clean the barrel with a cotton patch attached to a cleaning rod. Moisten the patch with cleaning solution. Repeat with clean patches until patch stays clean. Apply cleaning solvent to a bronze bore brush to help loosen particles inside the barrel. After cleaning, run a dry patch through the barrel and then follow with a lightly oiled patch.

CLEANING THE CHAMBER

-  Remove the magazine (if equipped) and verify that the firearm is not loaded and safety is on SAFE.

Clean the chamber with solvent and a chamber cleaning brush. Move the brush through the chamber several times to scrub the inside of the chamber. Use a clean patch wipe the chamber after cleaning. Repeat with clean patches until patch stays clean. After cleaning, run a dry patch through the chamber. Do not oil the chamber.

CLEANING THE EXTERIOR

-  Remove the magazine (if equipped) and verify that the firearm is not loaded and safety is on SAFE.

Wipe all metal surfaces with a clean cloth and then follow up with a lightly oiled cloth.

DEFINITION OF TERMS

Barrel – The tube through which the bullet travels when the firearm is fired.

Bolt – A sliding bar that pushes the cartridge into place and extracts the empty cartridge after firing.

Caliber – The diameter of the bolt, designated in hundredths or thousandth of an inch.

Handguard – This is a protective shield that covers the barrel keeping your hand from the hot barrel.

Firing Pin – A part of the firing mechanism.

Muzzle Brake – This reduces the amount of recoil when the weapon is fired.

Magazine – A metal receptacle for a number of cartridges, inserted into certain types of firearms and when empty removed and replaced by a full receptacle in order to continue firing.

Safety Selector Lever – This feature changes the trigger between the safe mode and the firing modes.

Sight – A device used to assist aim by guiding the eye.

Stock – The part located behind the breech mechanism in a firearm

Trigger – A small projecting tongue in a firearm that, when pressed by the finger, actuates the mechanism that discharges the weapon.

PARTS LISTINGS

RIFLE MAJOR COMPONENTS



Figure 36

A – Upper Receiver

B – Trigger Group

C – Stock

UPPER RECEIVER

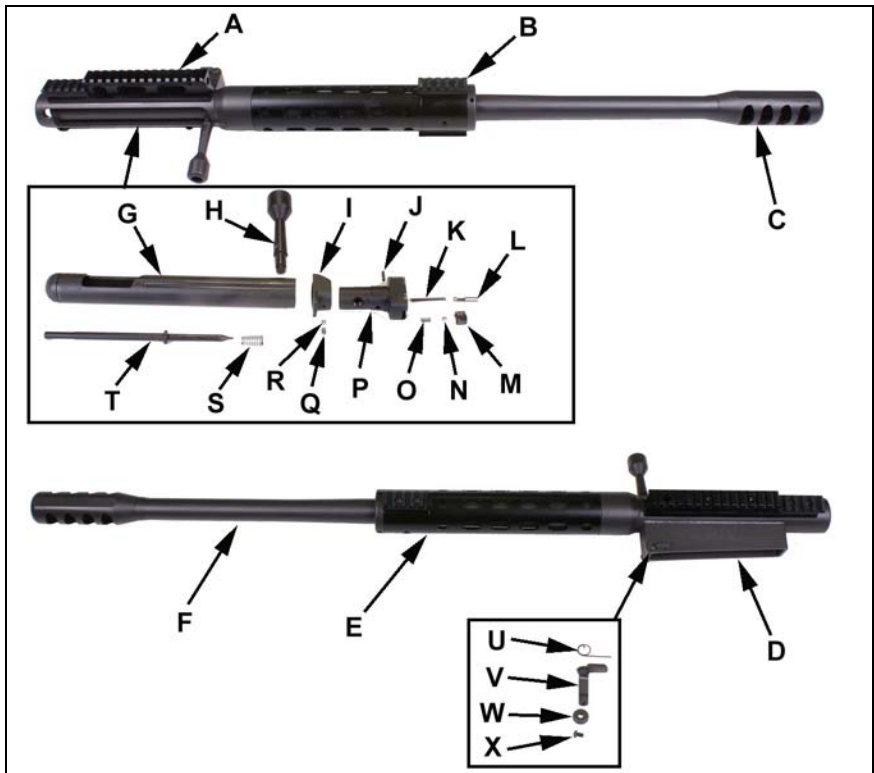

Figure 37

- A – Scope Rail
- B – Iron Sight Mounting Rail
- C – Muzzle Brake
- D – Magazine Well
- E – Hand Guard
- F – Barrel
- G – Bolt Body
- H – Bolt Handle
- I – Bolt Head Follower
- J – Ejector Pin
- K – Ejector Spring
- L – Ejector

- M – Extractor
- N – Extractor Ball
- O – Extractor Spring
- P – Bolt Head
- Q – Bolt Head Follower Spring
- R – Bolt Head Follower Ball
- S – Firing Pin Spring
- T – Firing Pin
- U – Magazine Latch Spring
- V – Magazine Latch
- W – Mag. Latch Spring Retainer
- X – Magazine Latch Screw

TRIGGER GROUP

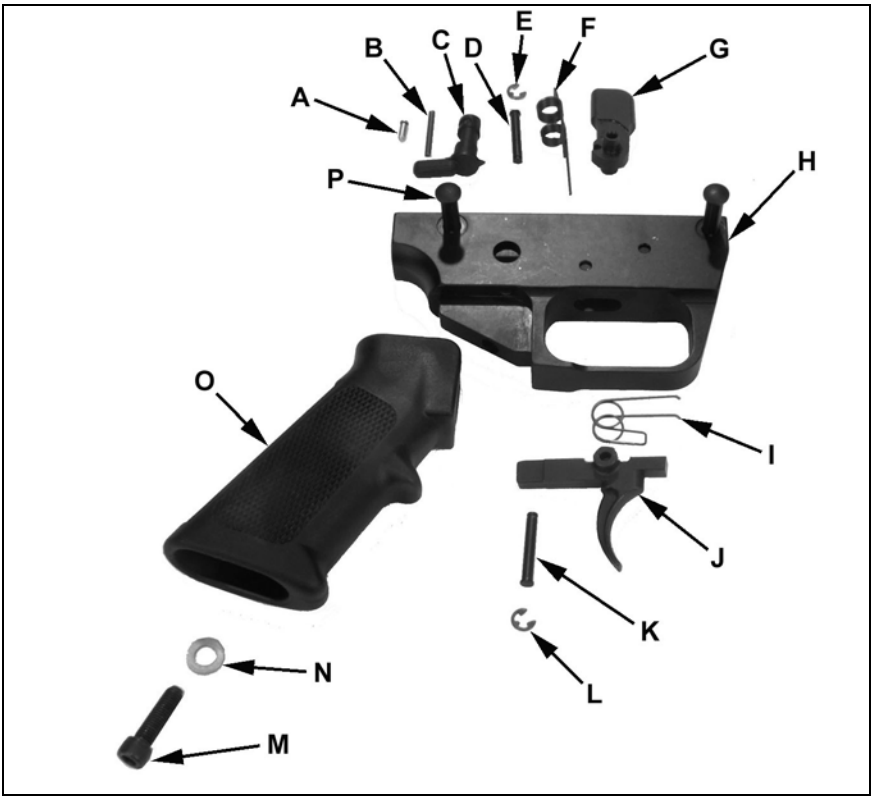

Figure 38

- A – Safety Detent
- B – Safety Spring
- C – Safety Lever
- D – Hammer Pin
- E – Hammer Pin C-Clip
- F – Hammer Spring
- G – Hammer
- H – Trigger Group Housing

- I – Trigger Spring
- J – Trigger
- K – Trigger Pin
- L – Trigger Pin C-Clip
- M – Grip Screw
- N – Washer
- O – Grip
- P – Trigger Group Retaining Pin

Stock

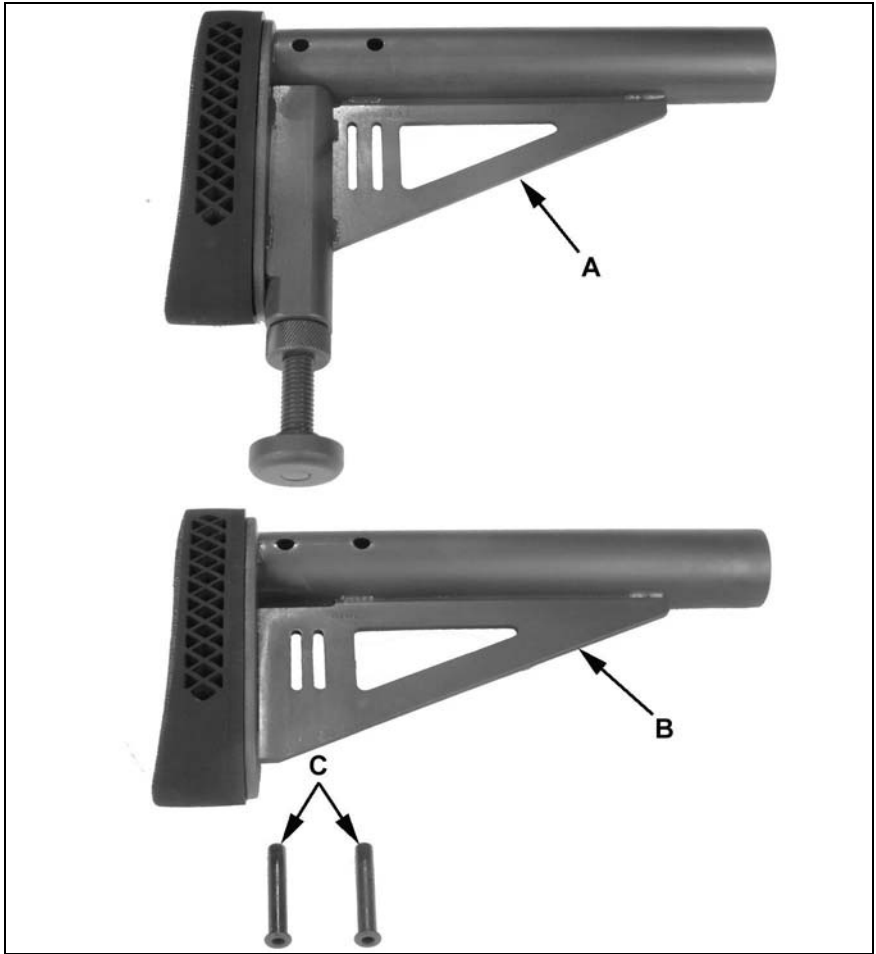

Figure 39

A – Mono Stock

B – Standard Stock

C – Retaining Pins

SERVICE

CUSTOMER SERVICE

If you have any questions about the Safety Harbor Firearms product line, call **727-726-2500** between 9:00 a.m.– 5:00 p.m. ET Monday – Friday (EST).

RETURNS

All unused, unopened products may be returned within 30 days. A restocking fee of 15% will be assessed. Returns must be approved ahead of time by calling **727-726-2500**. If a manufacturing defect or workmanship error is present, contact Safety Harbor Firearms and at the manufacturer's discretion it will be repaired or replaced.

EXCHANGES

Unused items may be exchanged within 30 days; include a copy of your invoice. Exchanges must be approved ahead of time by calling **727-726-2500**. Return all pieces wrapped and packaged securely. Insure the package for your protection.

Do **NOT** ship any ammunition. Do not attempt to ship a firearm via US Postal Service; only federally licensed dealers may ship a firearm by US Postal Service.

Safety Harbor Firearms, Inc.
PO Box 563
Safety Harbor, FL 34695-0563
Ph: 727-726-2500
Fax: 727-797-6134
www.safetyharborfirearms.com